

1. General Information - Specifications

⚠ ATTENTION - READ FIRST

1. This document is for quick guidance only. For details, please refer to the Energy Intelligence (EI) Inverter Installation & Operations Manual.
2. Damage caused by failure to follow the contents of the EI Inverter Installation & Operations Manual is not covered by the warranty.
3. Before installing the system, check that the package contents are intact and complete against the packing list. If any damage is found or any component is missing, contact your dealer.

1.1 Package Contents

Item	Quantity
EI Inverter	1
Quick Start Guide	1
Mounting Bracket	1
Tigo Access Point (TAP)	1
Rapid Shutdown label	1
E-stop button	1
DC wire ferrules	7.6kW: 16 11.4kW: 20
AC wire ferrules	5
RS485 3-pin connector (meter)	1
Grounding ring terminal	1
Hex-head Self tapping screws (inverter mounting)	5
Philips-head screw (E-stop mounting)	4
White wall anchors (inverter)	5
Green wall anchors (e-stop)	4
WiFi antenna	1
Cellular antenna (only in cell-enabled models)	1
3/4" conduit hole plug, with nut	1
1" conduit hole plug	2
1" conduit hole plug nut	2

1.2 AC Wiring Diagram

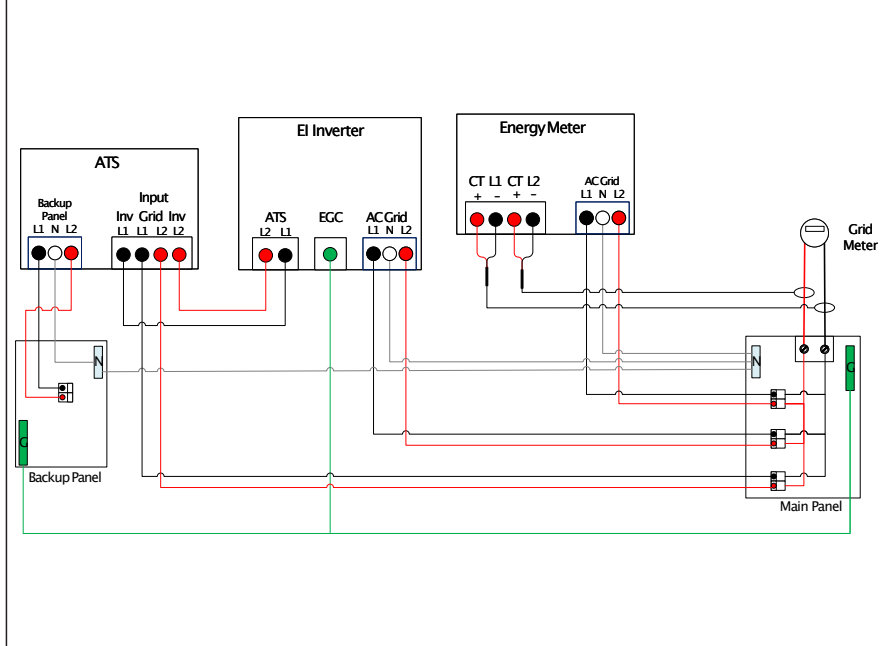

1.3 EI Inverter Overview

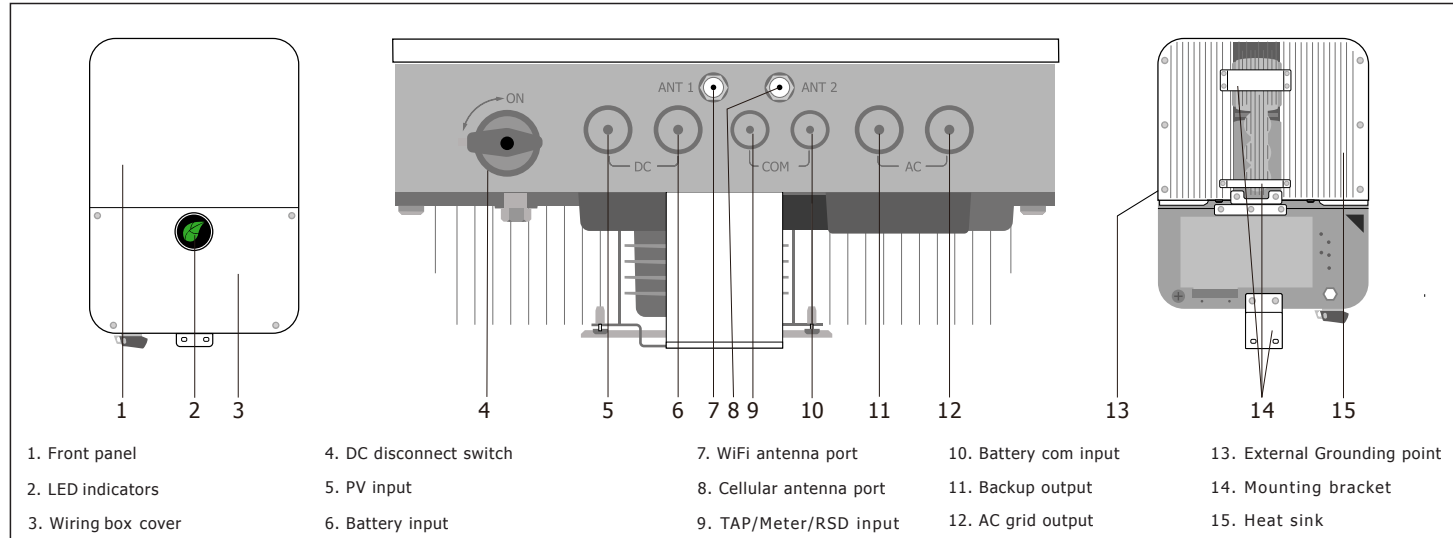

2. Installation

2.1 Installation requirements

1. Do NOT install the EI inverter in the direct sun, rain or snow
2. If installing more than one inverter, refer to the EI Inverter Installation & Operations Manual for clearances

Item	W (inch/mm)	H (inch/mm)	D (inch/mm)
TSI-7.6K-US	15.75/400	22.4/570	7/170
TSI-11.4K-US	15.75/400	25.2/638	7.4/187

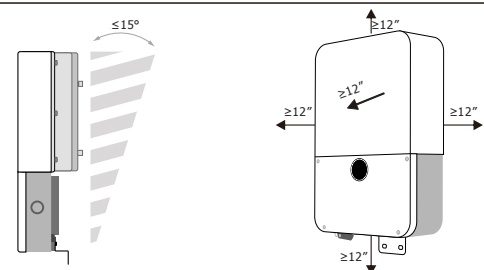

2.2 Prepare conduit openings

1. Determine which inputs/ports will need to be opened

References in Guides	Label on Inverter	# on diagram	Drill / if installing
PV input	DC (left side)	5	Yes
Battery input	DC (right side)	6	Yes / battery
Comm	COM (left side)	9	Yes / TAP or meter
Comm	COM (right side)	10	Yes / battery
Backup output	AC (left side)	11	Yes / ATS
AC grid output	AC (right side)	12	Yes

2. Remove wire box cover (3) using 3/16" (5mm) screwdriver
3. With a hole saw, CAREFULLY open the conduit drill guide for the necessary openings.

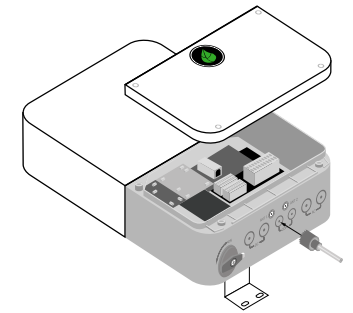

2.3 Mounting

⚠ CAUTION - Use appropriate hardware for the mounting surface

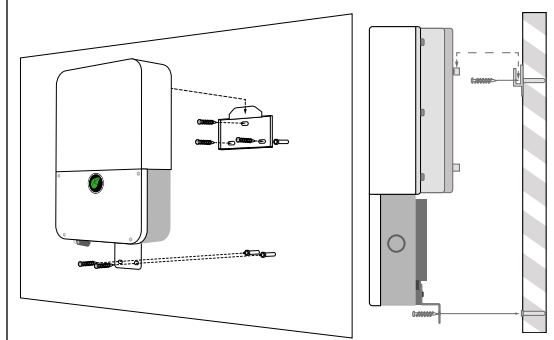

3. Electrical Connections

⚠ CAUTION - Check that all Disconnect switches are OFF before wiring. For personal safety, do not operate with electricity and always wear appropriate PPE.

3.1 Wire schedule/preparation

1. To prepare the DC conductors (PV+, PV- and BAT), strip 5/8"/16mm of the DC connector's jacket and crimp on the DC wire ferrule.
2. To prepare the AC conductors (GRID and BACKUP), strip 0.7"/18mm of the AC conductor's jacket and crimp on the AC wire ferrule.

Use	Type	Size
Equipment Grounding Conductors	Yellow-green jacketed or solid bare copper	10 - 8 AWG
AC output conductors (BACKUP/GRID)	Multi-color jacket, copper	8 - 6 AWG
PV Input conductors	Red/Black Photovoltaic Wire (ex: PV1-F)	10 - 8 AWG
Battery input conductors	Red/Black Photovoltaic Wire (ex: PV1-F)	12 - 8 AWG

3.2 Connections

3.2.1 Pressure Terminals

1. Insert 1/8" flat blade screwdriver in the terminal at a right angle to the terminal face. Press the clamp open by tilting down.
2. Insert conductor into the terminal's round opening.
3. Remove screwdriver to release the clamp and secure the conductor.
4. Gently tug conductor to ensure it is secure.

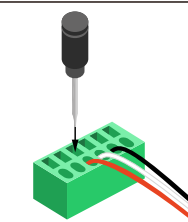

3.2.2 Screw Terminals

1. Insert equipment grounding conductor (EGC) into the grounding busbar.
2. Use an #2 philips screwdriver to tighten the set screw and securing the EGC.
3. Gently tug the conductor to ensure it is secure.

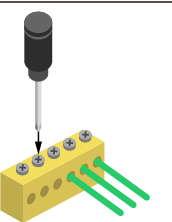

3.3 Inverter output connection - GRID

1. Install the AC conduit to the AC grid output opening (12). Use appropriate conduit fittings and bond where necessary. Run AC grid conductors.
2. Terminate the AC grid conductors to the appropriate terminal.

L2	L1	L1	N	L2
Backup		Grid		

3. Connect the AC EGC to the grounding busbar.
4. Terminate the opposite end of the inverter output conductors at the main service panel with the appropriately sized OCPD.

Inverter Model	Over current rating
TSI-7.6K-US	40A (bi-directional)
TSI-11.4K-US	60A (bi-directional)

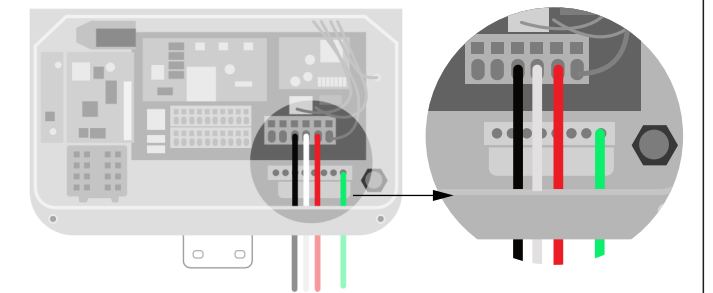

3.4 Backup output connection - Battery systems only

1. Install the AC conduit to the AC grid output opening (11). Use appropriate conduit fittings and bond where necessary. Run AC backup conductors.
2. Terminate the AC backup conductors to the appropriate terminal.

L2	L1	L1	N	L2
Backup		Grid		

3. Connect the AC EGC to the grounding busbar.
4. The opposite end of the Backup conductors terminate at the ATS. To complete the ATS connections at this time, refer to the ATS manual.

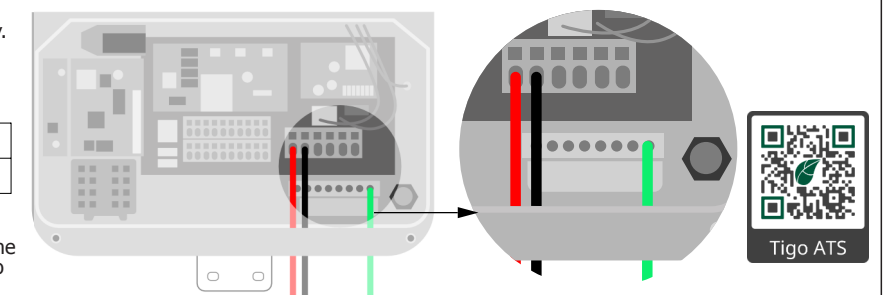

3.5 TS4 Installation

CAUTION - To prevent damage to the TS4, always connect PV modules to the TS4 input before connecting output conductors in the string. Refer to the TS4 Installation Manuals for the TS4 installation requirements.

1. Install the TS4 module-level power electronics (MLPE) on the back of the PV modules.
2. Connect the PV module to the TS4 input conductors.
3. Connect the TS4 output conductors together to form a string.
4. If using the TS4-A-F/TS4-A-2F, no additional steps are necessary.
5. Remove each barcode sticker from the TS4-A-O and place in the grid on the last page of this document in the position and orientation of the module as it is in the array. If using the TS4-A-F/TS4-A-2F, this step is not necessary.

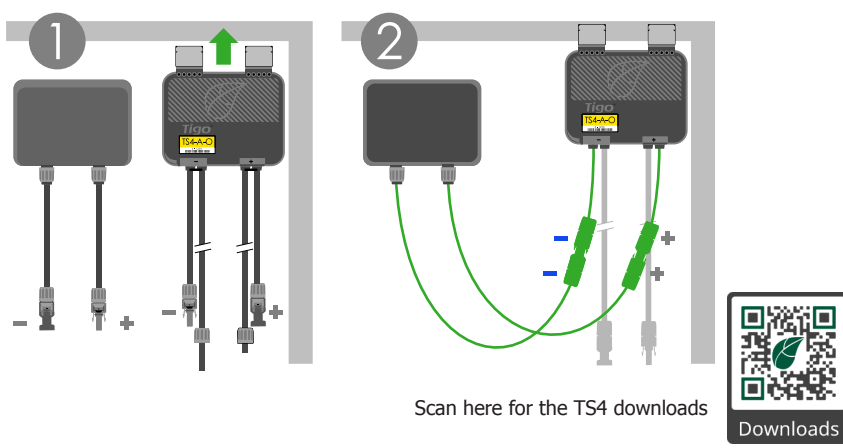

3.6 PV connections

NOTE: The TSI-7.6K-US has 3 MPPTs, the TSI-11.4K-US has 4 MPPTs.

1. Install the PV conduit to the DC PV input opening (5), use appropriate conduit fittings and bond where necessary. Run the PV string conductors.
2. Terminate the PV strings to the appropriate terminal.

1	2	3	4	1	2	3	4	+	-
PV+				PV-				BAT	

3. Connect the PV EGC to the grounding busbar.

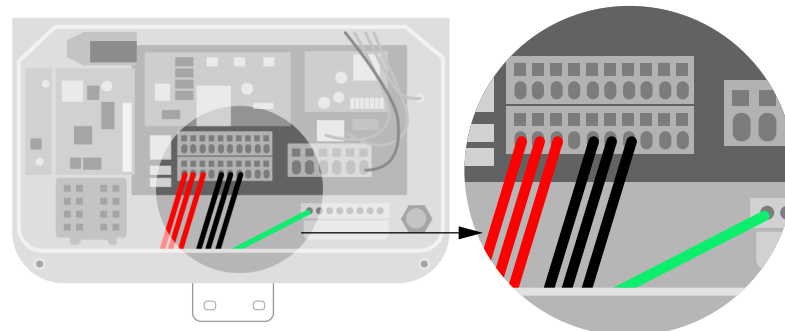

3.7 Battery connections - Battery systems only

CAUTION - Do not reverse positive and negative of the battery input terminal.

1. Install the Battery conduit to the DC Battery input opening (6), use appropriate conduit fittings and bond where necessary. Run the battery conductors.
2. Terminate the battery conductors to the appropriate terminal.

1	2	3	4	1	2	3	4	+	-
PV+				PV-				BAT	

3. Connect the battery EGC to the grounding busbar.

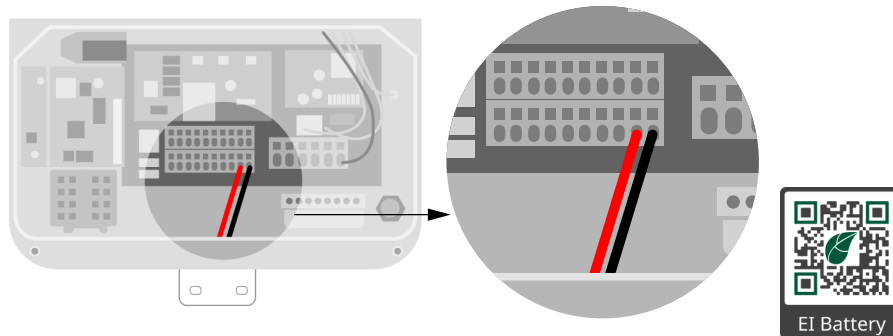

4. Communications connections

4.1 Tigo Access Point (TAP) installation

NOTE: The TAP is a required to enable module-level monitoring, and rapid shutdown functionality in the TS4-A-O.

1. Install the TAP within the array boundary.
2. Run the RS485 or CAT5/6 cable from the TAP to the inverter.
3. Terminate the TAP communications wire in the inverter at the 4-pin connector. From bottom to top: -, +, B, A.

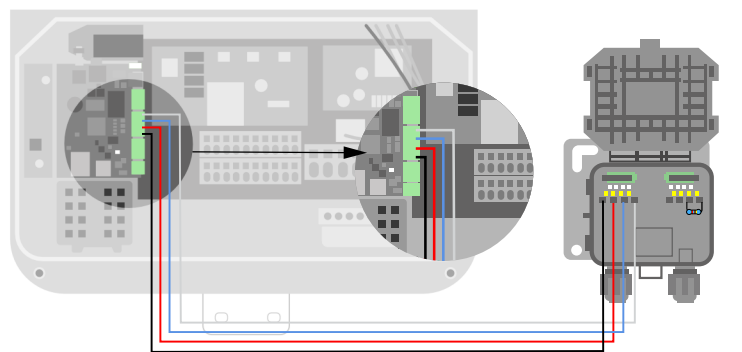

4.2 Battery communications - Battery systems only

1. Using a cable cutter/stripper, remove the 1/2in of the external insulation/jacket from the CAT5/6 cable, exposing the 4 twisted pairs of wire.
2. Untwist approximately 1/2in of the end of the wires and insert the eight wires into the an RJ45 connector. Choose either T568A or T568B standard for wiring – stay consistent.
3. Crimp the connector with the appropriate crimping tool.

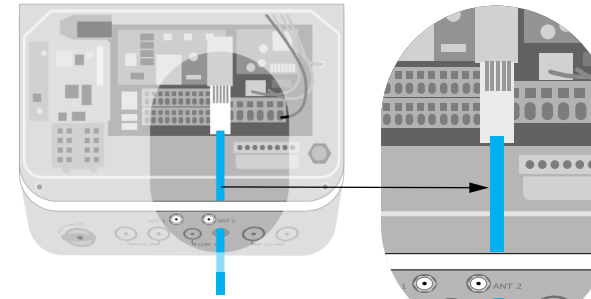

RJ45 Pin	Wire color		Signal definition	Function
	T568B	T568A		
1	White/Orange	White/Green	Enable+	Wake-up
2	Orange	Green	Enable-	
3	White/Green	White/Orange	CANL	CAN Communication
4	Blue	Blue	CANH	
5	White/Blue	White/Blue	GND	GND
6	Green	Orange	Received	NC
7	White/Brown	White/Brown	RS485B	RS485 communication
8	Brown	Brown	RS485A	

T568B

1 2 3 4 5 6 7 8

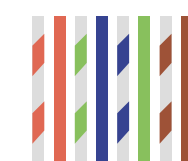

T568A

1 2 3 4 5 6 7 8

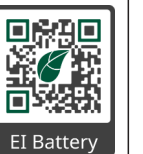
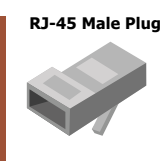
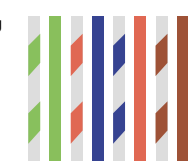

4. Install the battery communications conduit to the COM battery input opening (10), use appropriate conduit fittings and bond where necessary. Run battery CAT5/6 cable.
5. Connect the communications cable from the battery to the RJ45 port in the inverter wire box.

4.3 Meter connections

CAUTION - Do not cut or extend CT wires. The CTs wires are 80", plan accordingly.

NOTE: This connection is required for the operation of the EI Battery.

1. Install the meter communications conduit from the main service panel (location of the meter) to the inverter's TAP/meter COM input (9) and run the RS485 (3 wires needed). Additional wires may need to share this raceway (E-stop, TAP). Plan the conduit layout with this in mind.
2. Remove the cable's external insulation using a crimping tool or cable cutter.
3. Insert the RS485 communication cable into the 4-pin connector. Note – the farthest right terminal on the male adaptor is not used.
4. Plug connector into the meter communications terminal.
5. Clamp CT's around the corresponding grid input conductors (L1, L2) ensuring that the arrow is pointing away from the grid.
6. Connect the meter's L1, L2, N to the main service panel, using 15A circuit breaker on L1, L2.

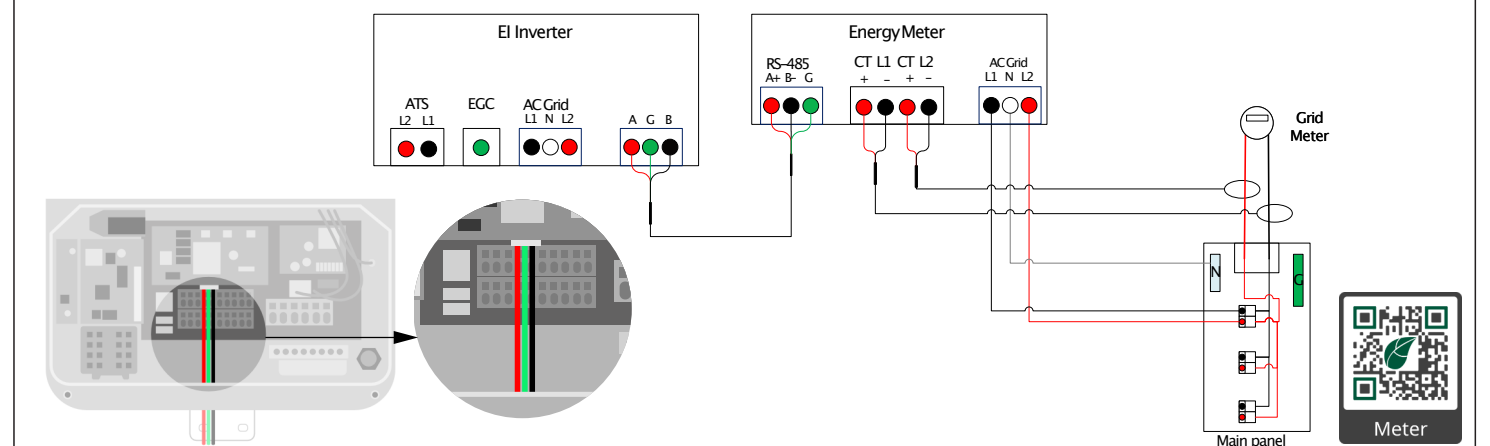

4.4 Antenna connections

NOTE: All EI Inverters come with the WiFi antenna. The cellular antenna is included for inverters which include this communication.

1. Carefully screw WiFi antenna in the WiFi antenna port, ANT1 (7).
2. If the inverter includes the cellular function, carefully screw the Cellular antenna in the Cellular antenna port, ANT2 (8).

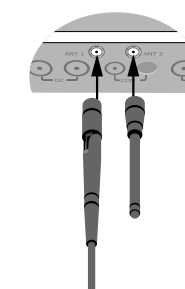

5. Pre-commissioning checklist

✓	Check Item	Acceptance Criteria
	Inverter installation	The inverter is installed correctly, securely and reliably.
	Conduit/Cable layout	Conduit/Cables and conductors are routed properly, and as requested by the customer.
	Cable connections	The AC output conductors, DC input conductors, and communications cables are labeled and connected correctly and securely.
	Cable ties	Cable ties are secured evenly with no sharp protrusions.
	Grounding	Ground conductors are connected correctly, securely and reliably.
	Conduit connections	All conduit attachments are sealed and bonded, when necessary.
	Unused conduit openings	Any unused conduit openings are fitted with waterproof caps (provided) or left unopened.
	Disconnect switches	The inverter's DC disconnect switch and all external disconnect switches connecting to the EI Inverter are in the OFF position.
	Wirebox cleanliness	The wirebox is left clean and tidy.
	Installation environment	An appropriate installation space had been chosen and the environment is left clean and accessible.

6. Commissioning

⚠ CAUTION - For personal safety always wear appropriate PPE.

The steps to turn on the inverter are as follows:

1. Before powering on, please make sure all voltages and current are within the specification of the inverter, otherwise damage may occur.
2. Turn on the DC disconnect switch between the battery and the inverter.
3. Turn on the DC disconnect switch at the bottom of the Tigo EI Inverter.
4. Turn on the BAT switch located on the left side of the Tigo EI Battery.
5. Turn on the service disconnect between the grid and the Tigo EI Inverter.
6. Ensure the e-stop button (if used) is not in the de-pressed position.
7. Open the Tigo EI app to complete commissioning by making all required inverter and battery settings.

NOTE: The shutdown steps are the opposite to the order above.



7. LED Status

TSI-7.6/11.4K-US inverters come with four LED indicators. On the front cover, from left to right, the indicators show POWER, Battery status, COM, and FAULT.

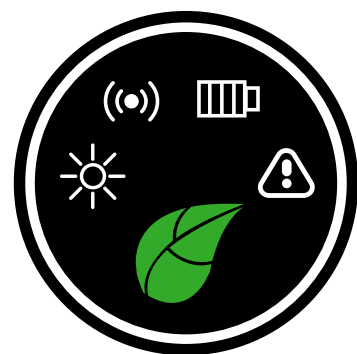

Symbol	Function	Color	Status	Action	Description
	POWER	Green	ON	Steady	Feed in grid
			Blink	3s on / 1s off	DC ON / AC OFF
			Blink	1s on / 3s off	DC OFF / AC ON
			Blink	0.5s on / 0.5s off	Checking
			Blink	2s on / 2s off	Standby mode
	COM	Green	ON	Steady	4G/WiFi, local WiFi ok
			Blink	0.5s on / 0.5s off	Local WiFi connecting
			Blink	1s on / 1s off	4G/WiFi failure, local WiFi ok
			Blink	1s on / 3s off	Local WiFi failure, 4G/WiFi ok
		Blank	Off	Steady	Communications failure
	BAT	Green	ON	Steady	Battery is in normal operation
			Blink	1s on / 3s off	Battery is in low power
			Blink	0.5s on / 0.5s off	Battery is in fault mode
	FAULT	Red	ON	Steady with audible buzzer alarm	Arc fault
			Blink	1s on / 1s off	Warning
			ON	Steady	Fault

8. PVRSS initiation switch

8.1 General Information

This Rapid Shutdown (RSD) initiation switch is intended to act as the National Electric Code (NEC) required activation device for rapid shutdown systems. The RSD switch is a normally closed (NC) contact. When the button is pushed, the state of the initiation switch is open and the system's PV array enters rapid shutdown in which all conductors from the modules to the Tigo EI inverter are reduced to less than 30V_{dc} within 30 seconds. This solution complies with the 2017 and 2020 NEC.

8.2 Required for installation

- Items needed for the installation:
- Signal conductors (24V rated)
 - Conduit and appropriate weatherproof connectors
 - Drill with 5mm bit
 - Philips head screwdriver
 - Installed EI Inverter

Included in the packaging for this installation:

Item	Quantity
Green plastic wall anchor	4
Philips-head self-tapping screws	4

8.3 Mounting the RSD initiation switch

⚠ CAUTION - Use appropriate hardware for the mounting surface.

1. Using a Philips head screwdriver, unscrew the 4 plastic screws of the assembled RSD initiation switch to open the enclosure.
2. Use the base of the enclosure to mark 4 holes on the wall and drill the holes out. Insert the wall anchors into the holes.
3. Align the holes of the RSD initiation switch base with the holes in the wall. Using a Philips screwdriver, screw the self tapping screws through the enclosure base into the wall anchors.

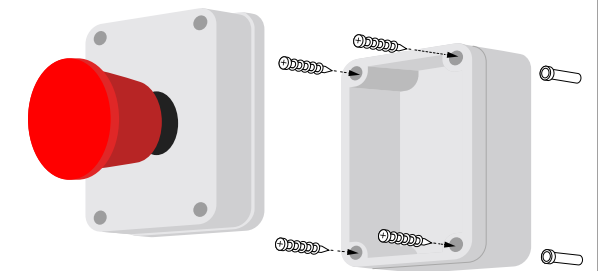

8.4 Wiring the RSD initiation switch

⚠ CAUTION - Make sure the inverter is OFF. Pull up on the RSD button to ensure it is in the "normally close" position.

1. Install RSD switch conduit to the TAP/Meter/RDS COM input (9), use appropriate conduit fittings and bond where necessary. Run the signal conductors.
2. Connect the conductors to the RSD switch as shown.
3. Reinstall the RSD initiation switch cover and tighten the plastic screws to secure.
4. Remove the 3-pin connector from terminal CN14 and remove the jumper across the pins.
5. Insert the conductors in the 3-pin conductor's positions 1 and 3, as shown.
6. Replace the connector in the terminal CN13 and replace the inverter wirebox cover.

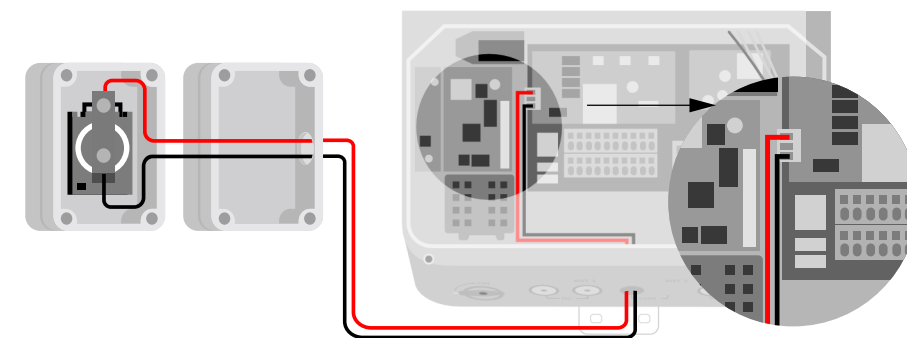

9. Your Customer Service Contact

Tigo Energy, Inc.

655 Campbell Technology Pkwy
Campbell, CA 95008

T: +1 408 402 0802
<https://support.tigoenergy.com/>



Place TS4-A-O barcode stickers in the grid below per the system azimuth and layout for scanning into the EI App.

Examples:

